

Unpacking

Before using the device, check the device model and ensure that the shipped box includes the following items:

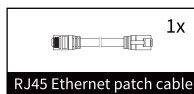

Wall-mounting Accessories :

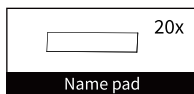
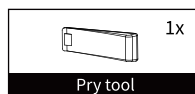
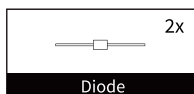
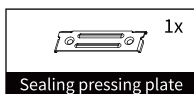
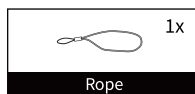
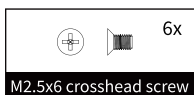
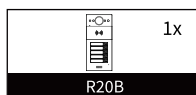
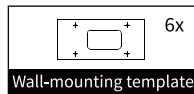
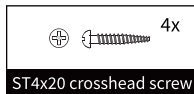
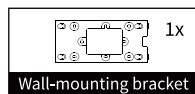
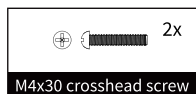

Product Overview

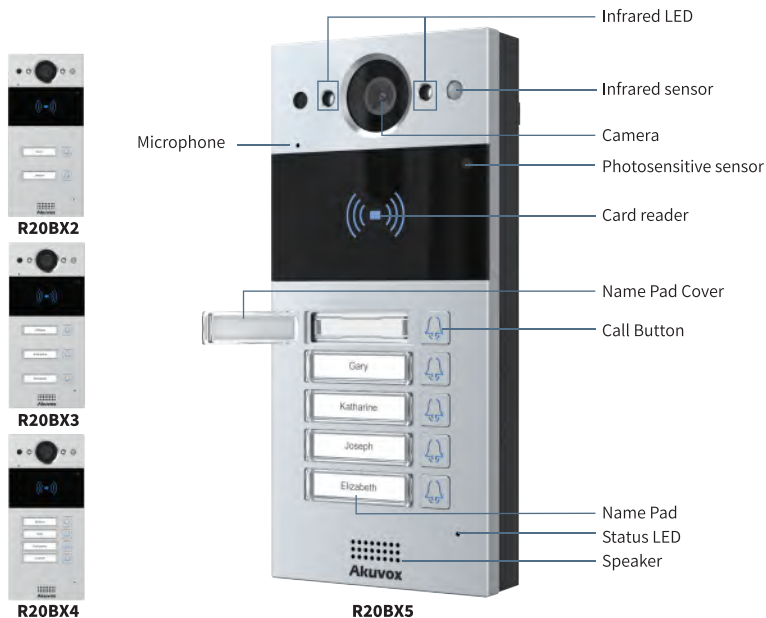

Before You Start

Tools needed

(not included in shipped box)

- Cat Ethernet Cable
- Crosshead Screwdriver
- Electric Drill

Voltage and Current Specifications

- It is suggested that use PoE or 12VDC 2A power adaptor to power on device.

AWG Sizes and Properties Table

Power Supply	12VDC 2A		
AWG	20	22	24
Resistance(ohm/km)	33.9	48.5	79.6
Cross-sectional Area(mm ²)	0.5189	0.3247	0.2047
Wire Length(m)	≤50	≤40	≤20

Requirements

1. Place the device away from sunlight and light sources to prevent potential damage.
2. Do not place the device in the high-temperature, and humid environments or in surroundings impacted by magnetic field.
3. Install the device on the flat surface securely to avoid personal injuries and property loss caused by device' s falling.
4. Do not use or place the device near heating objects.
5. If installing the device indoors, please keep device at least 2 meters away from light, and at least 3 meters away from window and door.

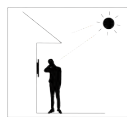

Backlight

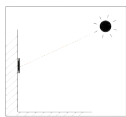

Direct sunlight

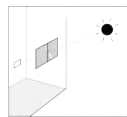

Direct sun through window



Indirect sunlight through window

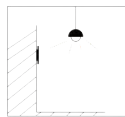

Close to light

Warning!

1. To ensure safety, avoid touching power cord, power adapter, and device with wet hands, bending or pulling the power cord, damaging any components, and use only qualified power adapter and power cord.
2. Be careful that standing up on the area under the device in case of personal injuries cause by hitting the device.

Caution

1. Do not knock device with hard objects.
2. Do not press down hard on the device screen.
3. Do not expose device to chemical products, such as alcohol, acid liquid, disinfectants, and so on.
4. To prevent the device installation from becoming loose, ensure accurate diameters and depths of screw holes. If the screw holes are too large, use glue to secure the screws.
5. Use wet cloth clean device surface softly, and then wipe the surface with dry cloth for cleaning the device.
6. If there is abnormal situation of the device, including uncommon sound and smell, please power off the device and contact Akuvox Technical Team immediately.

Wiring Interface

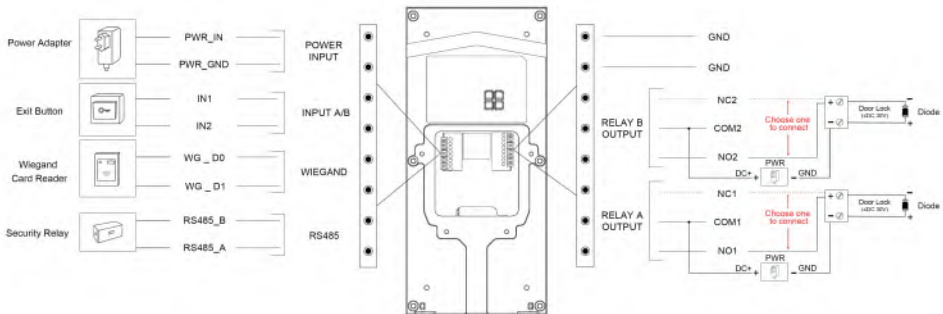

To protect the device from potential damage caused by over-voltage, it is recommended to wire a diode into the circuit. Connect the anode of the diode to the negative cable of the lock, and connect the cathode of the diode to the positive cable of the lock.

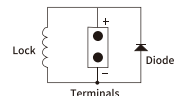

Installation

Step 1: Wall-mounting Bracket Installation

1. With electrical junction box in the wall

1.1 With an 86x86 mm junction box

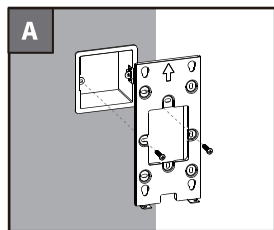

Fix the **wall-mounting bracket** on 86x86 mm junction box with two **M4x30 crosshead screws**.

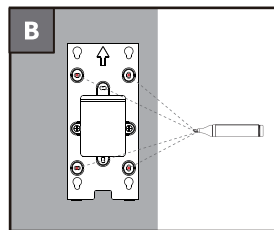

Mark the four holes on the wall.

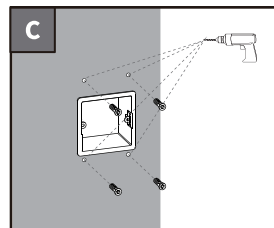

- Take off the **wall-mounting bracket**.
- Use a 6 mm hand drill to make four marked fixing holes with a depth of 25 mm.
- Insert four **plastic wall anchors** into the screw holes.

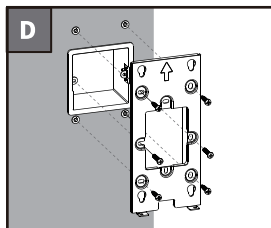

Tighten the **wall-mounting bracket** and junction box on the wall with four **ST4x20 crosshead screws** and two **M4x30 crosshead screws**.

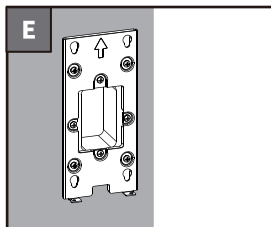

Finish the wall-mounting bracket installation.

1.2 With a 2x3 inches junction box.

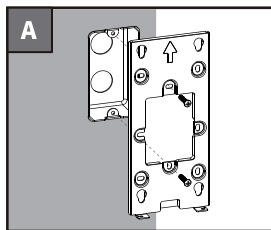

Fix the **wall-mounting bracket** on the 2x3 inches junction box with two **M4x30 crosshead screws**.

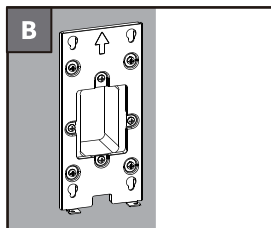

Finish the wall-mounting bracket installation.

2. Without embedded junction box in the wall

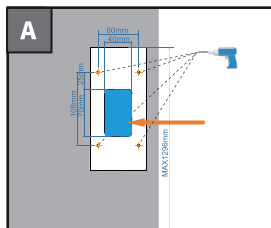

- Use a 6 mm hand drill to make four screw holes with a depth of 25 mm.
- Cut a rectangular hole on the wall with the diameter of 40x70 mm and depth of 40 mm.

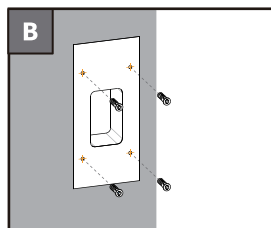

Insert four **plastic wall anchors** into the holes.

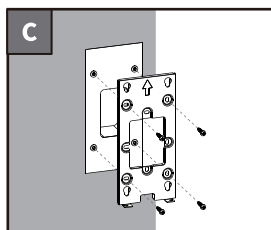

Fix the **wall-mounting bracket** on the wall using four **ST4x20 crosshead screws**.

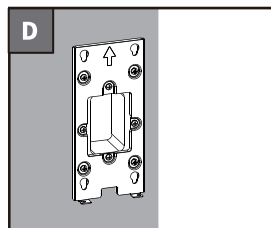

Finish the wall-mounting bracket installation.

Step 2: Main Unit Installation

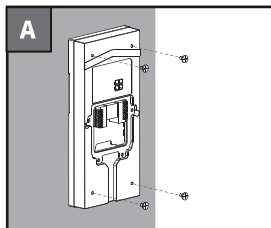

Install four **wall-mounting screws** to the back of device.

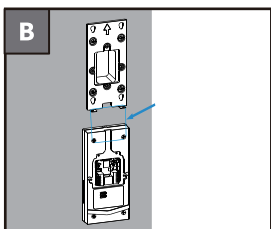

Hang R20B on **the wall-mounting bracket** with **rope**.

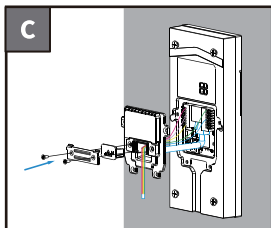

- Make cables go through the **wiring cover**, connecting to the corresponding interfaces of the main board.
- Select a suitable size **rubber plug** to push all the cables into the back cover.
- Fix **sealing pressing plate** to the **wiring cover** with two **M2.5x6 crosshead screws**.

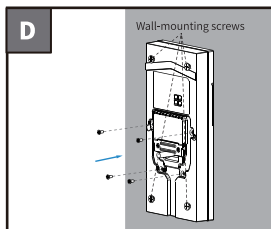

Fasten the back cover with four **M2.5x6 crosshead screws**.



YS20000085

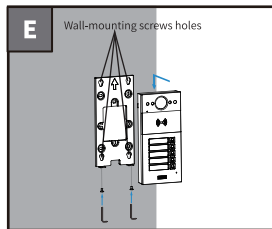

- Insert four **wall-mounting screws** on the device into the corresponding holes on the **wall-mounting bracket**.
- Press down to slide the **wall-mounting screws** into the groove.
- Use **Allen Wrench** to tighten the device with two **M3x6 hex socket screws**.

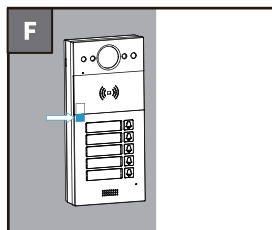

Installation completed, please remove the protective film.

Application Network Topology

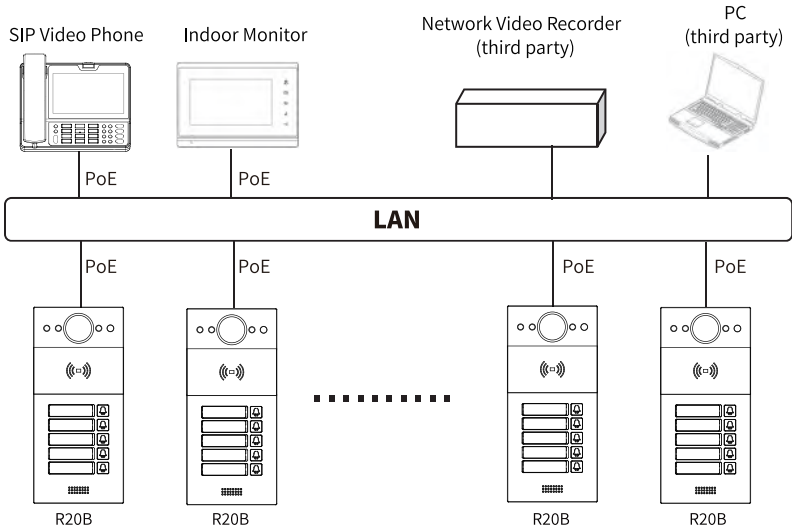

LED Status Information

LED Status		Description
Blue	Always on	Normal status
	Flashing	Calling
Red	Flashing	Offline
Green	Always on	Talking on a call
	Flashing	Receiving a call

Note: For more LED settings, please refer to R20B WEB: **Intercom > LED Setting** .

Device Test

Please verify the device status after installation:

- Network:** Press and hold **Call button** to obtain IP address, network is working properly if the device announce IP address. If no IP address is obtained, E12X will announce "IP 0.0.0.0" .
- Intercom:** Press **Call button** to make a call. The call configuration is correct if the call is successful.
- Access Control:** Use pre-configured RF card to unlock door.

Warranty

- Akuvox warranty does not cover intentional mechanical damage or destruction caused by improper installation.
- Do not attempt to modify, alternate, maintain, or repair device by yourself. Akuvox warranty does not apply to damages caused by anyone who is not representative of Akuvox or an Akuvox authorized service provider. Please contact Akuvox Technical Team if the device need to be repaired.

Get Help

For help or more assistance, contact us at:



<https://ticket.akuvox.com/>



support@akuvox.com

Scan the QR code to get more videos, guides, and additional product information.



Notice Information

Information contained in this document is believed to be accurate and reliable at the time of printing. This document is subject to change without notice, any update to this document can be viewed on Akuvox's website: <http://www.akuvox.com> © Copyright 2024 Akuvox Ltd. All rights reserved.

